



Open Access Journals – dissemination and integration in modern library services

15th Panhellenic Academic Libraries
Conference,

Patras, November 2006

Lars Björnshauge,
Director of Libraries
Lund University



Introductory statements

- Libraries and Librarians have played a very important role in promoting and lobbying for Open Access to scholarly literature.
- Libraries and Librarians play a very important role in and advocacy for self-archiving and development of Institutional Repositories.
- We can be very proud of that!!
- We still have a lot to do when it comes to promoting access to the **Open Access content** in OA journals and Institutional repositories!



Agenda

- Part I:
 - Brief introduction to the Directory of Open Access Journals (DOAJ)
 - Dissemination of Open Access Journals
- Part II:
 - Integration of Open Access Journals in library services



Part I

Directory of Open Access Journals



Purpose of the DOAJ:

- making it easier for
 - **readers** to find OA-material
 - **authors** to find a journal to publish in OA
 - **OA-publishers** to get their journals visible
 - **aggregators & libraries** to integrate OA-journals data in their services



What we hope to see ...

Increased visibility and access to Open Access journals

= Increased usage

= Increased citation

= Increased impact

= Increased usage...

etc etc



What is DOAJ:

- A collection of **peer reviewed** open access journals
- SCOPE: All disciplines – all languages
- One interface
- Provides search service for end-users
- Provides metadata harvesting services based on the OAI-PMH protocol for libraries and other service providers



Selection criteria

- Open Access
 - no embargo!
- Quality control measures,
 - the journal must exercise peer-review or editorial quality control in order to be included in the DOAJ.
- Scientific or scholarly content
 - The researcher as primary target group



Open Access – our definition:

Open access journals = journals that use a funding model that **does not charge readers or their institutions for access.**

The BOAI definition of "open access" = the right of **"users to read, download, copy, distribute, print, search, or link to the full texts of these articles"** as mandatory criteria



- **History:**

- Initiated during the first Nordic Conference on Scholarly Communication in Lund/Copenhagen October 2002
- Initially funded by Open Society Institute and co-funded by SPARC
- Project started January 2003
- Service launched 12th of May 2003 with 300+ journals



Number of journals listed in the DOAJ

- May 2003: 300
- November 2003: 558
- May 2004: 1097
- November 2004: 1345
- May 2005: 1601
- November 2005: 1905
- May 2006: 2230
- November 2006: 2450



The Editorial process (simplified)

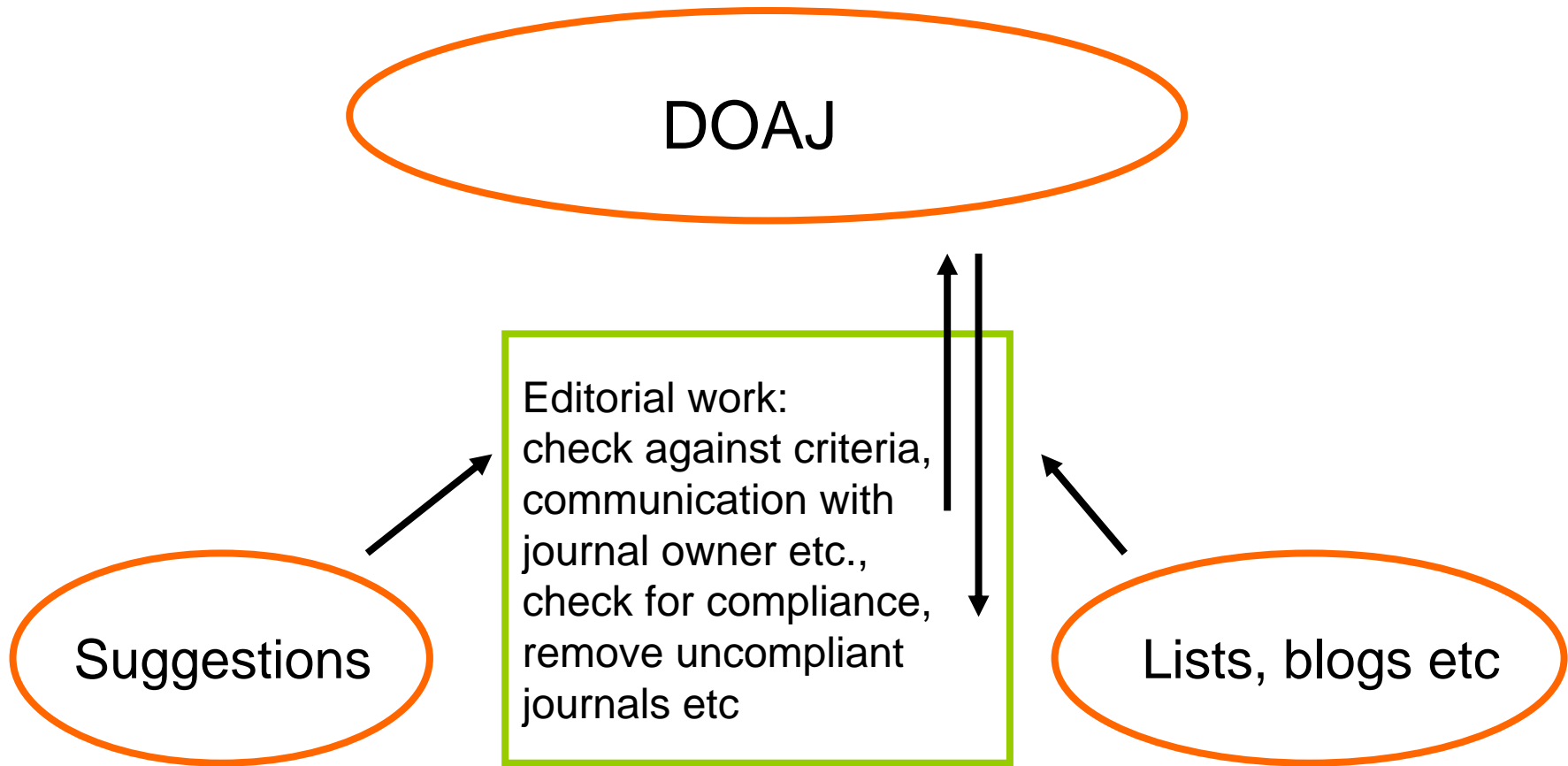

[Find Journals](#)

[New titles \(added the last 30 days\)](#)

[New titles](#)

52 journals added the last 30 days

[Find articles](#)

[Suggest a journal](#)

[ACTA BIOLÓGICA COLOMBIANA](#)

ISSN: 0120548X

Subject: [Biology](#)

Publisher: Universidad Nacional de Colombia

Language: Spanish, English

Keywords: biological sciences

Start year: 2005

[About](#)

[FAQ](#)

[News](#)

[Cooperation](#)

[Contact](#)

[Alfa Redi: Revista de Derecho Informático](#)

ISSN: 16815726

Subject: [Computer Science](#) --- [Law](#)

Publisher: Comunidad Alfa-Redi

Language: Spanish, Portuguese, English

Keywords: computer law, information society

Start year: 1998

[For journal
owners](#)

[For authors](#)

[Annals of "Dunarea de Jos" University of Galati, Fascicle III, Electrotechnics,
Electronics, Automatic Control, Informatics](#)

ISSN: 1221454X

Subject: [Electrical and Nuclear Engineering](#) --- [Computer Science](#)

Publisher: "Dunarea de Jos" University of Galati, Romania

Language: English

Keywords: computer science, electrical engineering, automatic control, industrial electronics, telecommunications

Start year: 2000

[Archivar. Mitteilungsblatt für deutsches Archivwesen](#)



Language	Number of journals receiving articles in that language (September 2005)
English	1535
Spanish	314
Portuguese	172
French	101
German	73
Japanese	30
Italian	28
Russian	19
Turkish	13
Catalan	6
Croatian	4
Greek	4
Chinese	4

Percentage of journals with OA content available from

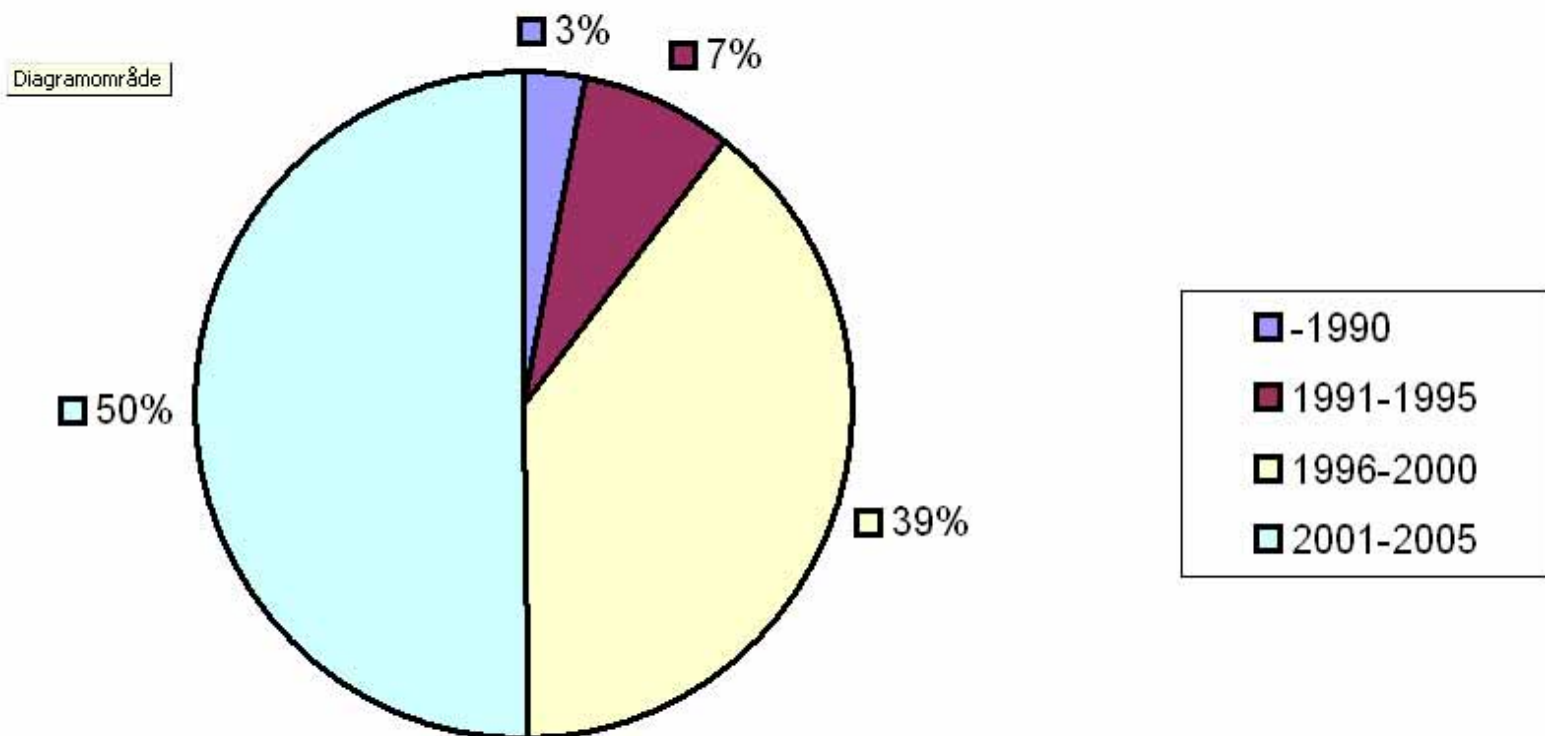



Usage of the DOAJ service

- Every month visits from 160+ countries
- Requested files increasing
- Distinct host served increasing
- Amount of data transferred increasing
- Visits from OAI-harvesters increasing
- Number of abstracts presented increasing
- Number of links to articles followed increasing

Successful requests per month

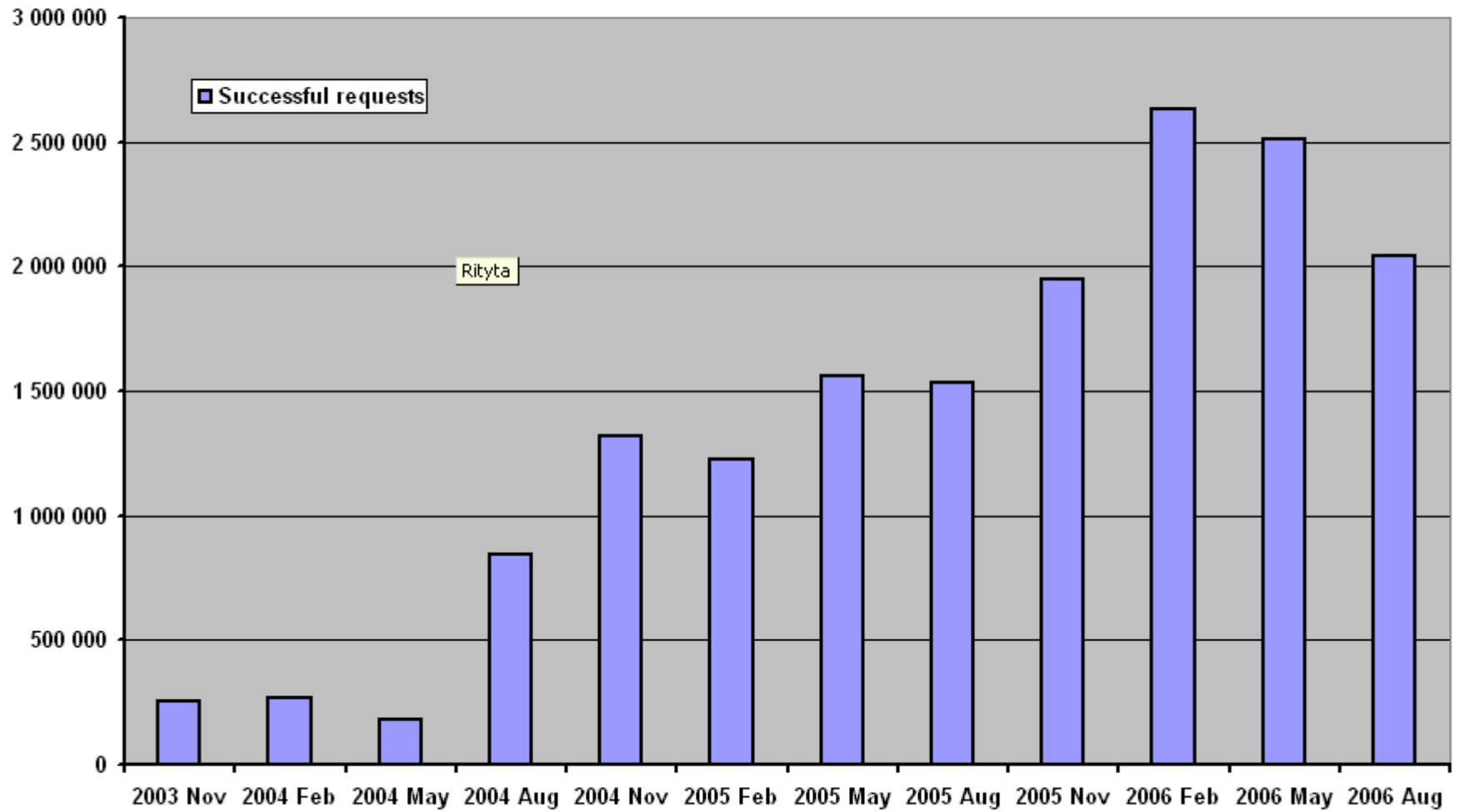



Using DOAJ for searching/browsing

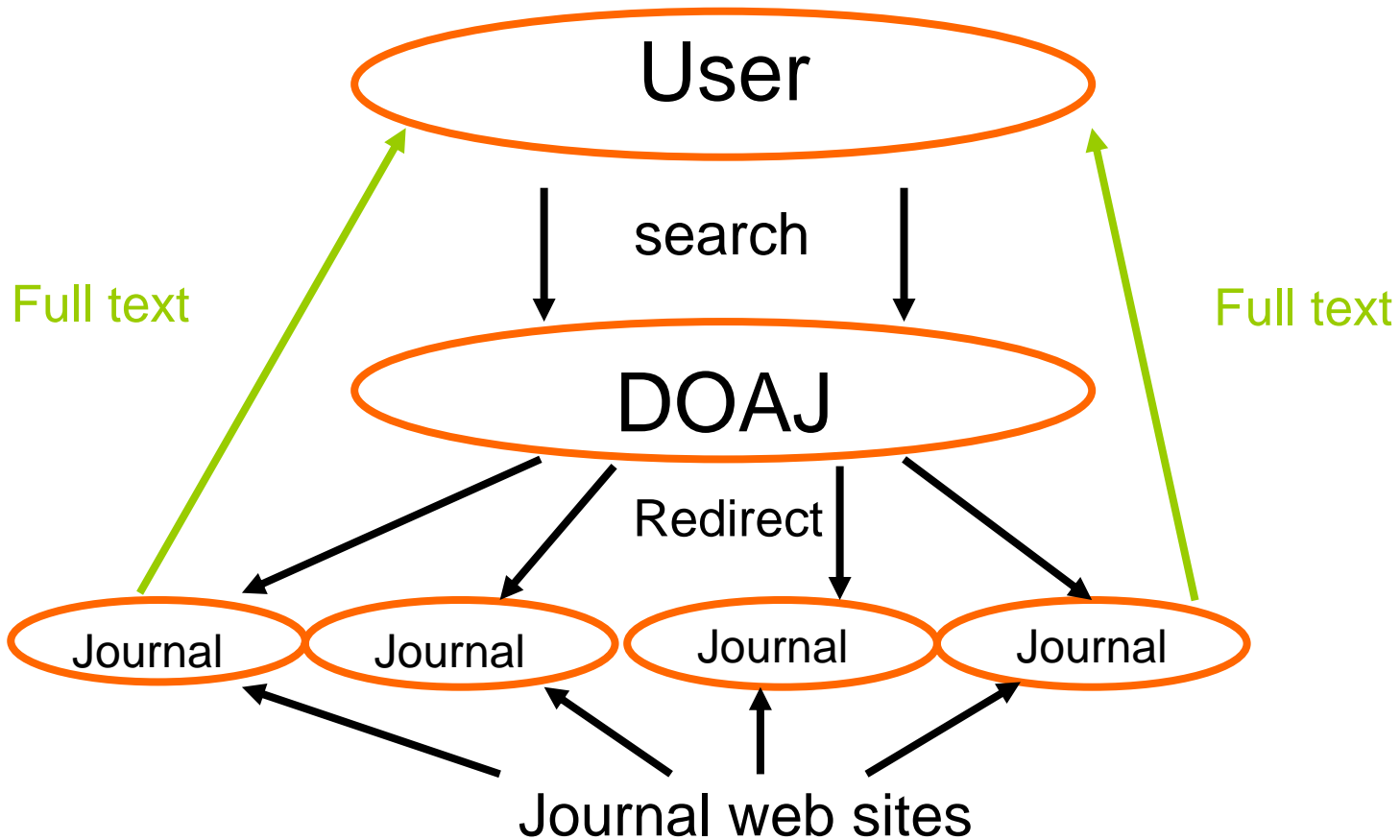

+ 500.000 redirects per month

[Find Journals](#)

Find articles

[New titles](#)

(more than one word in a field will be treated as **phrase**)

[Find articles](#)

[Suggest a journal](#)

bird flu

In: All Fields

[About](#)

AND OR NOT

[FAQ](#)

In: All Fields

[News](#)

[Cooperation](#)

[Contact](#)

[Support DOAJ](#)

[For journal
owners](#)

[For authors](#)

[Find Journals](#)

[New titles](#)

[Find articles](#)

[Suggest a journal](#)

[About](#)

[FAQ](#)

[News](#)

[Cooperation](#)

[Contact](#)

[Support DOAJ](#)

[For journal
owners](#)

[For authors](#)

Find articles

Found 3 documents matching your query :
*All Fields=*bird flu



Presenting page 1/1



Bird Flu: A recent threat to human health

Author: Asad U. Khan **Journal:** Bioinformation **Year:** 2006 **Vol:** 1 **Issue:** 4

Pages/record No.: 132-132

[View record](#)

[Fulltext](#)

Searching of Main Cause Leading to Severe Influenza A Virus Mutations and Consequently to Influenza Pandemics/Epidemics

Author: Guang Wu and Shaomin Yan **Journal:** American Journal of Infectious Diseases
Year: 2005 **Vol:** 1 **Issue:** 2 **Pages/record No.:** 116-123

[View record](#)

[Fulltext](#)

Avian influenza a (H5N1): A preliminary review

Author: Padhi S ; Panigrahi P ; Mahapatra A ; Mahapatra S **Journal:** Indian Journal of
Medical Microbiology **Year:** 2004 **Vol:** 22 **Issue:** 3 **Pages/record No.:** 143-146

[View record](#)

[Fulltext](#)

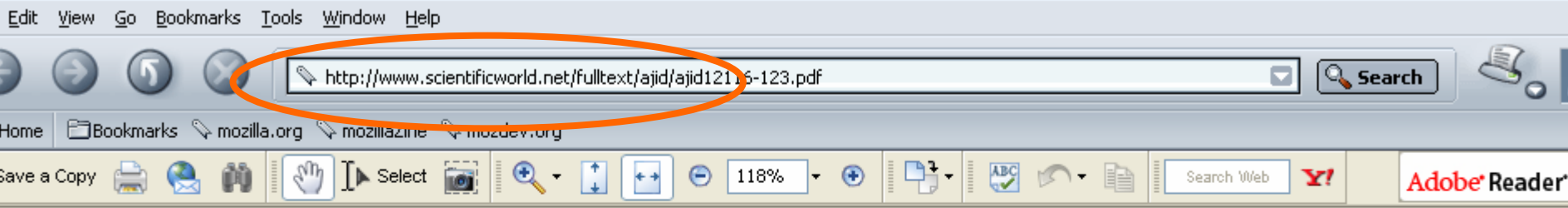

American Journal of Infectious Diseases 1 (2): 116-123, 2005
ISSN 1553-6203
© 2006 Science Publications

Searching of Main Cause Leading to Severe Influenza A Virus Mutations and Consequently to Influenza Pandemics/Epidemics

Guang Wu and Shaomin Yan

Computational Mutation Project, DreamSciTech Consulting, 301, Building 12, Nanyou A-zone
Jiannan Road, Shenzhen, Guangdong Province, CN-518054, China

Abstract: The unpredictable mutations in the proteins from influenza A virus lead to the great difficulty in prevention of possible outbreak of bird flu and pandemic/epidemic of influenza. This unpredictability is due to the fact that we know little about the causes that lead to the mutations. In three of our recent studies on the hemagglutinins from influenza A virus, we unintentionally noticed the periodicity of mutations in hemagglutinins similar to the periodicity of sunspot. We calculated the amino-acid pair predictability and amino-acid distribution rank, which are developed by us over last several years and can numerically present the evolution of proteins in question, of 1217 full-length hemagglutinins from influenza A viruses. We then used the fast Fourier transform to determine the periodicity of mutations in the hemagglutinins. We compare the periodicities of mutations in influenza A virus hemagglutinins with those of solar and galactic cosmic rays and find a main periodicity of the mutations identical to that of sunspot and neutron rate (11 years/circle). Then we plot the sunspot number with respect to the historical pandemics/epidemics/non-pandemic new strains over last three centuries and compare the recorded sunspots with the historical pandemics before 1700. Both show a good agreement between sunspot activity and influenza related events. As the histories of Sun and

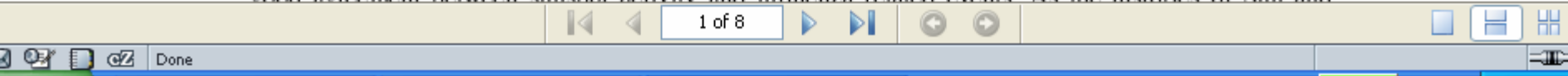



Web [Images](#) [video](#) [News](#) [Maps](#) [more »](#)

Searching of Main Cause Leading to Severe | Search

[Advanced Search](#)
[Preferences](#)

The "AND" operator is unnecessary -- we include all search terms by default. [\[details\]](#)

b Results 1 - 3 of about 58 for [Searching of Main Cause Leading to Severe Influenza A Virus Mutations and Consequently to Influenza Pandemics/Epidemics](#)

larly articles for [Searching of Main Cause Leading to Severe Influenza A Virus Mutations and Consequently to Influenza Pandemics/Epidemics](#)

- [Origins of Human Virus Diversity](#) - Sharp - Cited by 10
- [Virus Dynamics: Mathematical Principles of Immunology ...](#) - Nowak - Cited by 100
- [Tick-borne encephalitis](#) - Gritsun - Cited by 29

[Searching of main cause leading to severe influenza A virus ...](#)

[Searching of main cause leading to severe influenza A virus mutations and consequently to influenza pandemics/epidemics](#). Am J Infect Dis ...
[flu.org.cn/en/article-4895.html](#) - 10k - [Cached](#) - [Similar pages](#)

[\[PDF\] Searching of Main Cause Leading to Severe Influenza A Virus ...](#)

File Format: PDF/Adobe Acrobat - [View as HTML](#)
[Searching of Main Cause Leading to Severe Influenza. A Virus Mutations and Consequently to Influenza Pandemics/Epidemics](#). Guang Wu and Shaomin Yan ...
[www.flu.org.cn/upfile/attachment/20061010102535664.pdf](#) - [Similar pages](#)
[\[More results from www.flu.org.cn \]](#)

[Directory of open access journals](#)

[Searching of Main Cause Leading to Severe Influenza A Virus Mutations and consequently to Influenza Pandemics/Epidemics ...](#)
[doaj.org/abstract?id=175608&toc=y](#) - 10k - [Cached](#) - [Similar pages](#)

der to show you the most relevant results, we have omitted some entries very similar to the 3 already displayed. If you like, you can [repeat the search with the omitted results included](#).

Searching of Main Cause Leading t Search

Redirected requests per month

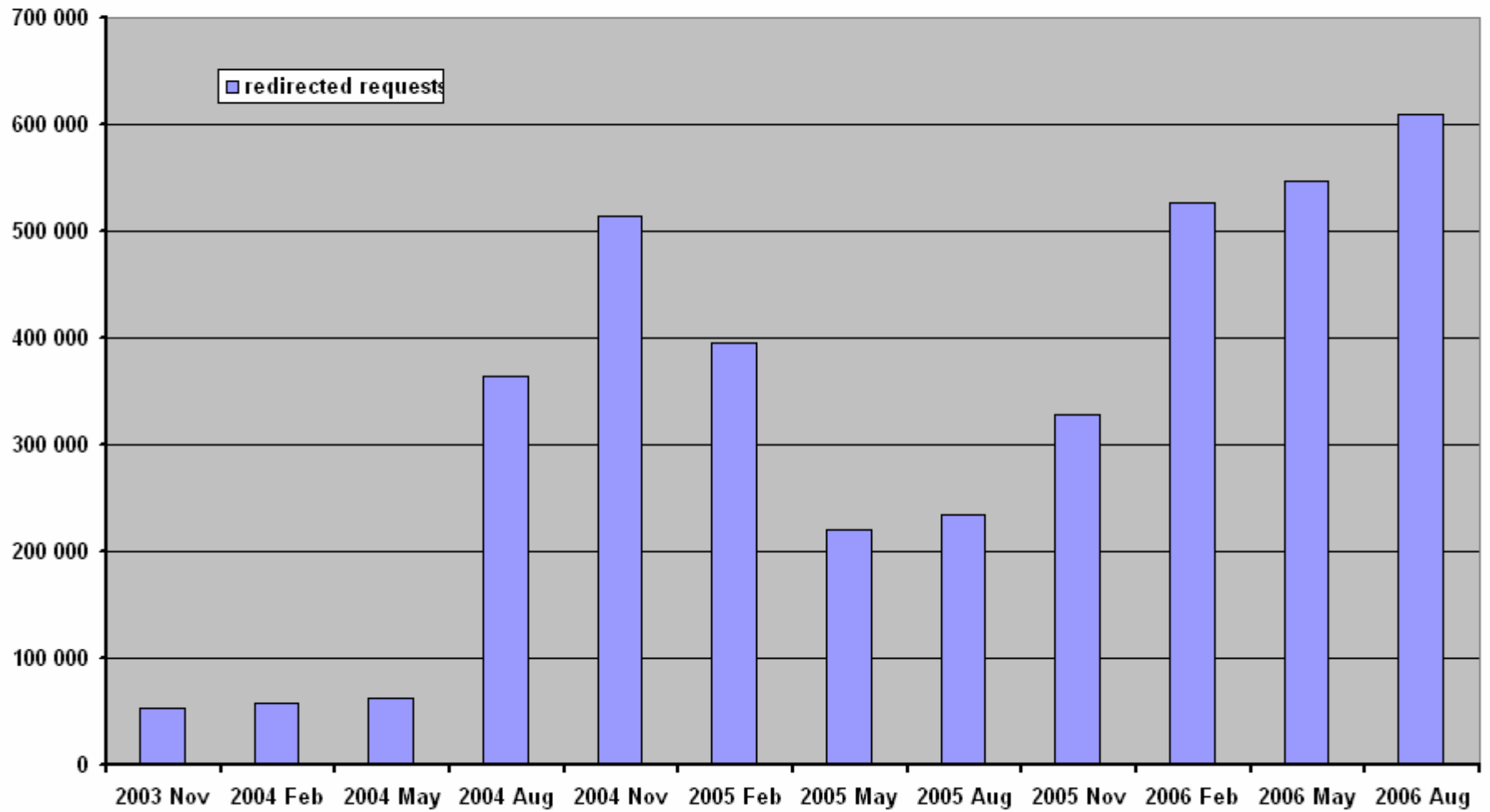



Using DOAJ for harvesting Metadata

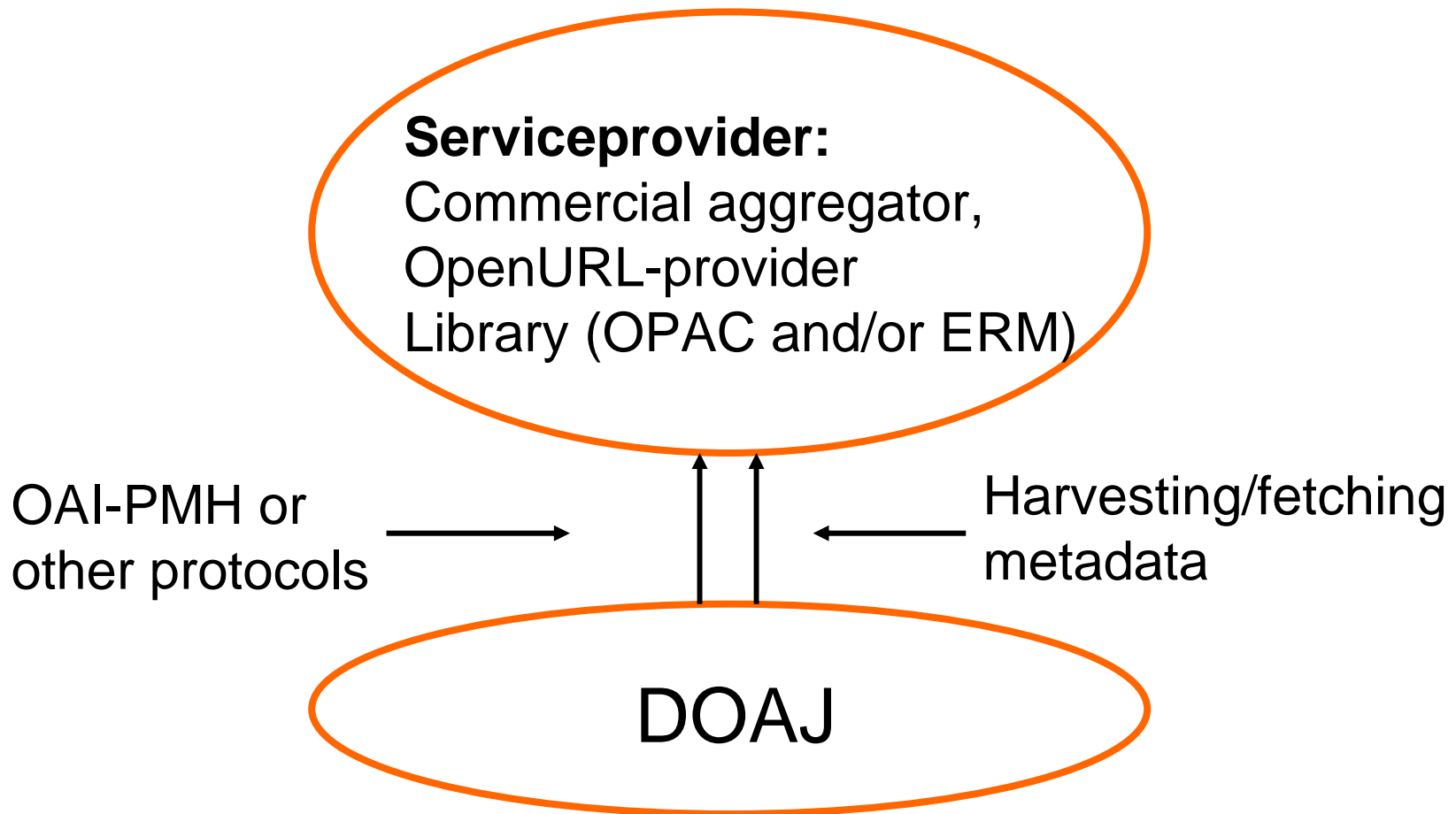

How can I get journal metadata from DOAJ?

The DOAJ service supports the OAI protocol for metadata harvesting ([OAI-PMH](#)). Thus, any other service can obtain records from DOAJ for inclusion in their collection. OAI is well established, and easy to use. The base URL is: <http://www.doaj.org/oai>. You can add most OAI verbs and other commands directly on that. A few examples:

Verb: Identify

<http://www.doaj.org/oai?verb=Identify>

Verb: ListMetadataFormats

<http://www.doaj.org/oai?verb=ListMetadataFormats>

Verb: ListRecords&from=2004-01-01&metadataPrefix=oai_dc

http://www.doaj.org/oai?verb=ListRecords&from=2004-03-01&metadataPrefix=oai_dc

From these URLs you'll get both an idea of what OAI is, and much of our metadata. See also [our example](#).

You have also the possibility to download the list of records in DOAJ in a comma separated format. Then you can import the file to Excel or some other software to use the records further. Do as follows:

- Download the file from <http://www.doaj.org/doaj?func=csv> to your own computer
- Open e.g. Excel
- Go to the menu Data -> Get External Data -> Import Text File
- From there you can choose how you want the spread sheet to look like e.g., delimited-> Comma -> General

How do I get article level metadata from DOAJ?

The article level metadata can be harvested using OAI protocol.

The base URL is: <http://www.doaj.org/oai.article>

Use OAI verbs and other command options directly on that.

Example:

Verb: ListRecords&from=2004-07-01&metadataPrefix=oai_dc

http://www.doaj.org/oai.article?verb=ListRecords&from=2004-07-15&metadataPrefix=oai_dc

Do you have any restrictions for the use of your metadata?

Distinct hosts served per month

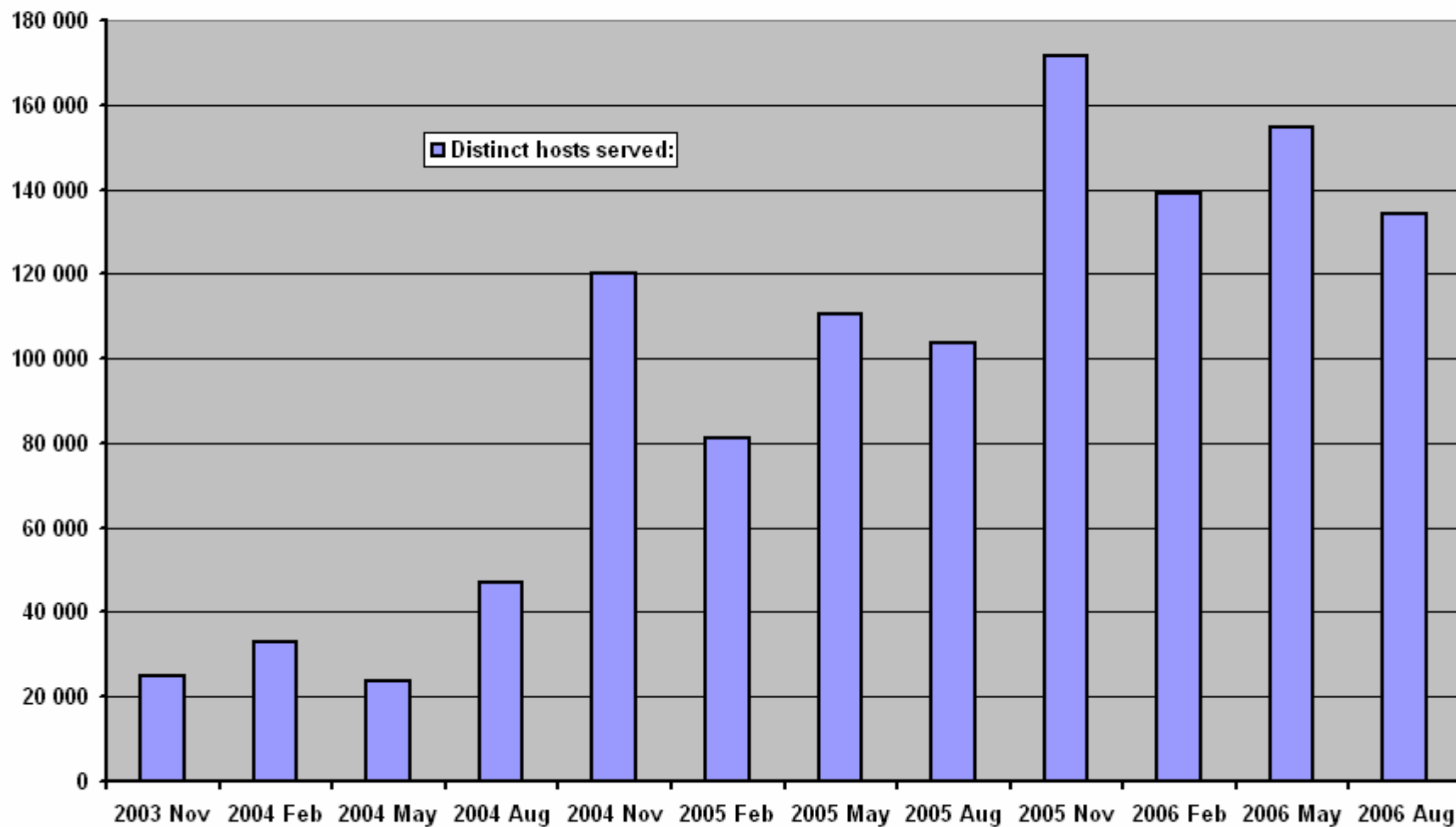

Average data transferred per day MB

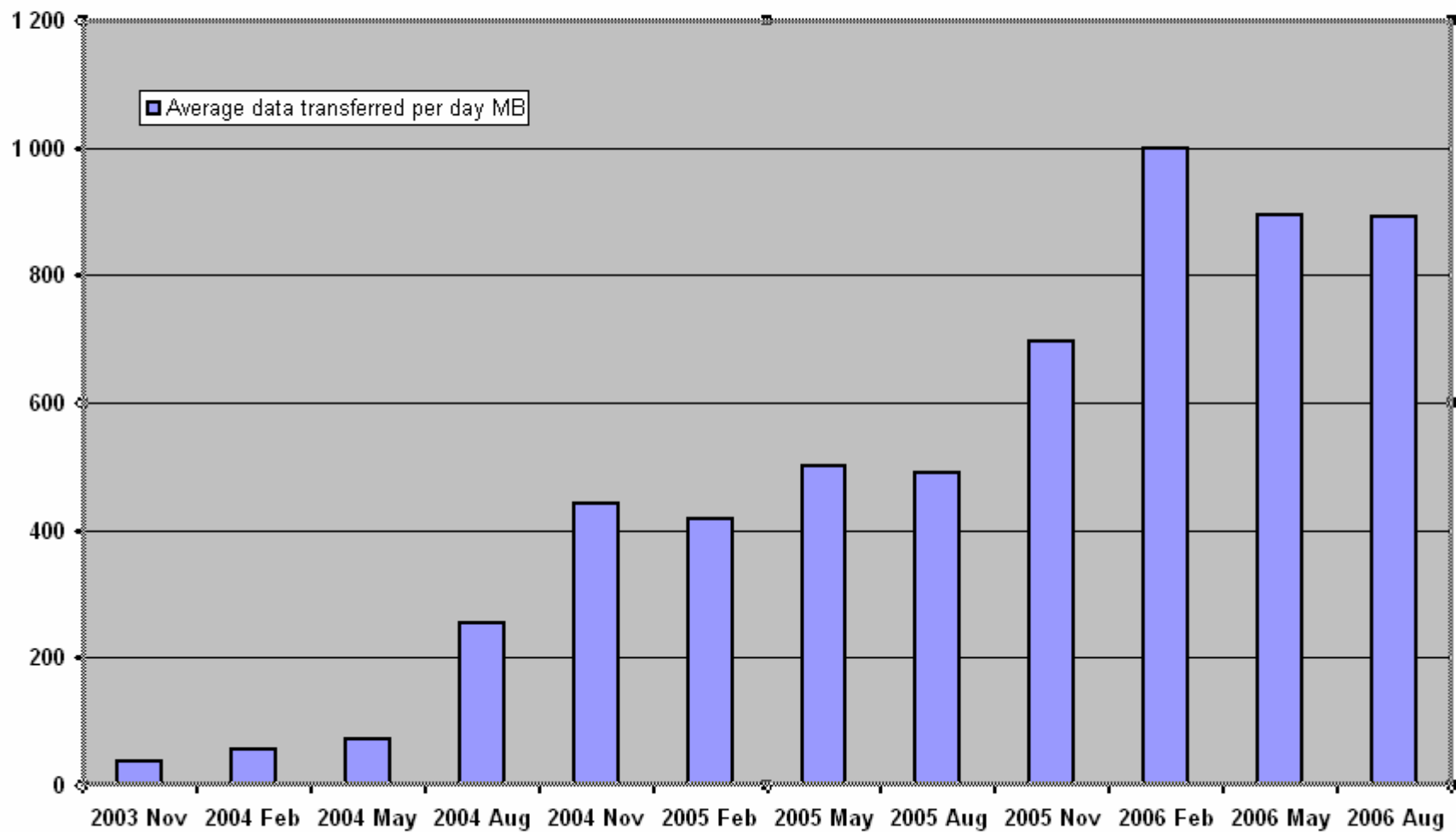



电子文献

- 数据库
- 电子期刊
- 学科信息
- 科技在线
- 网络信息
- 开放目录

信息服务

- 问图书馆员
- 文献传递服务
- 我的图书馆
- 随易通

用户培训

- 网上教室
- 服务百所行
- 网络资源推介
- 信息资源报道

项目管理 >>>

热点链接 >>>



检索

网络数据库一览表

请自觉遵守国家知识产权法，合理使用数据库资源。

- 全文类型数据库
- 文摘类型数据库
- 其他类型
- 试用和谈判中的数据库

数据库名称	简介
<p>中西日俄文期刊联合目录库</p> 	<p>该库揭示了全国499个文献情报机构收藏的94744种期刊的馆藏情况，读者可通过数据库查询了解到所需期刊在哪个图书馆收藏，并可通过数据库中的馆藏单位信息窗口直接向收藏单位提出原文传递（复印）的请求</p>
<p>中科院文献情报中心西文文献数据库</p>	<p>以我馆收藏的西文科技期刊和西文会议录为基础，快速报道期刊篇名目次、文摘，会议论文目次、文摘等信息，数据库起始年为1998年，报道时差为期刊到馆两周，年数据量25万条，目前已累计数据100万条，</p>
<p>中科院学位论文文摘数据库</p>	<p>报道和揭示中国科学院培养毕业学生的硕士博士论文和博士后报告的内容，著录内容有题名、论文作者、学位信息，中英文关键词、作者中英文文摘，导师信息等，收录年代从1980年到2001年，现有数据2万多条</p>
<p>DOAJ</p> 	<p>免费全文科技期刊</p> 

www.qiji.cn/eprint/
奇迹文库 (?) /baike/

: 本服务器位于公网: 奇迹文库 | 自然科学 | 工程科学 | 人文科学 | 科学报道
: 教育网内速度慢的: 北京信息 | 旅行天下 | 休闲娱乐 | 商务服务 | 生活服务
: 请使用代理服务器: 奇迹百科 | 各地指南 | 综合参考 | 百科知识 | 奇迹论坛

· 首页 · 添加资料 (请先找到合适分类) · 更改资料 · 新到资料 · 热门资料 · 光荣榜 · 邮件组 · 用户登录 ·

Google搜索本站:

搜索

使用帮助 意见建议 [详细搜索]

用户名:

密码:

登录

- 立即注册

欢迎来到奇迹论文预印本项目，第一次来访，请阅读使用帮助，并立即注册帐户。支持我们，请在利用互联网开放共享科研论文倡议书上签名（最新签字留言）。

如果你忘记了帐户的密码，我们可以Email给你。

奇迹日记

进入

“民科”——我们共同的原罪
再论民科：民间资源与振兴中国科学
又论民科：让科学在民间开花
科学发现来源于无功利的交流和讨论
普通与量子物理 / 天文与空间科学
生命科学与技术 / 纳米科学与技术
投稿信箱：ianwest@sina.com

其他电子文库

更多

arXiv.org 物理/数学/计算机/生物
CiteSeer 计算机科学
ScienceDirect 化学/数学/计算机
Cogprints 认知科学
BESPrints 认知科学
ICIP Preprints 数学、物理学
PubMed Central 医学
E-Print network 自然科学
Cryptology Archive 密码学

其他开放资源

PLOS 公共图书馆 (生物、医学)
PNAS 美国科学院院刊
NJOP 新物理杂志
DOAJ 开放杂志目录总汇
NAOP 物理学网络精华
MIT OCW 开放课件 (国内镜像)
NIST V-Lib 虚拟图书馆
PlanetWorld 网络科学资源
PlanetMath 数学百科全书
中科院科技信息资源与服务

奇迹论文预印本项目：分类

奇迹论文预印本项目是专门为中国研究者开发定制的电子文库，主要收录原创科研论文、综述、学位论文、讲义及专著（或其章节）的预印本及电子书。

现共有 8761 注册用户，资料 2426 项。[建议新分类]

自然科学：

物理学（综合，场论/粒子物理，引力/天体物理，凝聚态物理，介观系统，超导导电，光学，核物理，原子分子和团簇物理，等离子体物理，化学物理，数学物理，物理学交叉学科） - **数学**（代数，分析，几何，拓扑，逻辑，微分方程，数学史，数值分析） - **生命科学**（生物信息学，进化论/生态学，遗传学，分子与细胞，神经科学，疾病与医学） - **化学化工** - **地球科学** - **科学与社会**（科学传播，科学与政策，科学史科学哲学）

工程科学与技术：

计算机科学（人工智能，并行与集群计算，编程，信息检索，计算理论） - **电子工程**（通信工程） - **信号处理**（数字信号，语音处理，模式识别，水声信号） - **材料科学**（纳米技术，软物质） - **机械工程** - **系统科学** - **力学** - **环境科学**

人文与社会科学：

艺术 - 语言学 - 历史学 - 人类学 - 哲学 - 教育学 - 心理学 - 社会学 - 政治学 - 军事 - 法学 - 经济与管理 - 新闻与传播

其他分类：科学随想 - 毕业论文 - 图书交流 - 共享软件 - TeX科学软件

新到资料：[科学报道] [百科知识] [科学前线] [星空写真] [奇迹报道(2003-2004)]

- 新概念测量学（下卷） [书籍章节]
- 宇宙时空论：超光速原理，宇宙的起源，时空的本质 [预印本]
- 新概念测量学（中卷） [书籍章节]
- 新概念测量学（上卷） [书籍章节]
- 芝麻开门：神奇的汽车防盗系统 [新闻]
- 手机会面临病毒威胁吗？ [新闻]
- 更加安全的量子密码技术 [新闻]
- 一类无标度合作网络的演化模型 [预印本]
- 微波激光与激光的诞生 [新闻]
- 欧洲最大推力火箭阿丽亚娜5改进型发射成功 [新闻]
- Fortran77和90 / 95编程入门 [讲义笔记]
- 美国国立卫生研究院 (NIH) 制定开放科学文献政策 [新闻]
- 物理学家观察到“端态” [新闻]
- 科学家发现宇宙“失踪”重子痕迹 [新闻]
- 北京科技大学2004——2005学年度第一学期《量子力学》课程讲义 [预印本]

图片新闻



芝麻开门：神奇的汽车防盗系统

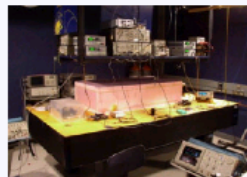



A-to-Z

Titles Subjects Search About This Site

Reactions Weekly" to "Rendiconti del Seminario Matem" [dropdown arrow]

Find: Search [Advanced search](#)

A B C D E F G H I J K L M N O P Q **R** S T U V W X Y Z
RA RB RC RD **RE** RF RG RH RI RJ RK RL RM RN RO RP RQ RR RS RT RU RV RW RX RY RZ

Page: next | 1 2 3 4 5 6 7 8 9 10 11 12 13 14 15 16 17 18 19
Titles where title name begins with 'RE': 184

Reactions Weekly
EBSCOhost EJS 2000 - 2003 Your Access: Jan 1 2002 - Oct 9 2004
SN: 0114-9954
Publisher: Adis International Limited
Subject: Medicine -- Therapeutics, Pharmacology

Reading in a foreign language
DOAJ: Directory of Open Access Journals 2002 to present
SN: 0264-2425 Online ISSN: 1539-0578
Publisher: University of Hawaii
Subject: Language and literature

The reading matrix: an international online journal
DOAJ: Directory of Open Access Journals 2001 to present
SN: 1533-242X
Publisher: University of Notre Dame
Subject: Language and literature

Reading online
DOAJ: Directory of Open Access Journals 1997 to present
SN: 1096-1232
Publisher: International Reading Association
Subject: Education -- Theory and practice of education

Recueil International de Législation Sanitaire
Free Medical Journals 1998 to present

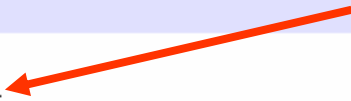

The global source for periodicals information since 1932

Welcome to
ulrichsweb.com™
 the first place to find magazines, journals,
 newspapers, newsletters, 'zines and more

Take a tour of ulrichsweb.com™

[LOGIN](#) >

Quick Search

Keyword

Browse by General Subject:

[Art](#) | [Economics](#) | [Humanities](#) | [Law](#) | [Science](#) | [Medicine](#) | [More...](#)

Browse by Index:

[Title](#) | [Subject](#) | [Electronic Vendor](#) | [Language](#) | [More...](#)



Open Access Journals

OPEN ACCESS IN ULRICH'S! In response to the evolving opportunities in serials information, ulrichsweb.com is now showcasing Open Access (OA) journals -- free electronic full-text academic and scholarly journals from SPARC, PLoS, Biomed Central, the [Directory of Open Access Journals](#), and other providers. Ulrichsweb.com subscribers can now search for and directly access the home pages and full-text of hundreds of these exciting new research resources. An "Open Access" search limiter on the Advanced Search screen lets users pinpoint Open Access titles. In addition, a new "Free" price limit lets users identify all of the free publications in Ulrich's -- whether print or electronic -- including journals, magazines, newspapers, newsletters and other serials.

Magazines for Libraries

Do you need to define core journals for your academic or research institution? Are you looking for the best magazines for a small or medium sized public library? [Click here](#) to learn how Bowker can help.



Ulrich's Free Areas

INSIDE ULRICH'S

[Go](#) >

Get to know ulrichsweb.com by reading [About ulrichsweb.com](#), or a list of [Frequently Asked Questions \(FAQs\)](#). Learn how it all started by reading the story of Carolyn Ulrich, and how today's serials librarians are recognized by the [Bowker/Ulrich's Serials Librarianship Award](#). Click to see the list of [Award Recipients](#).

WHAT'S NEW

[Go](#) >

Find out what's new on ulrichsweb.com™, including new features, enhanced functionality, and more! Read our [Press Releases](#) and about [Recent Site Enhancements](#).

ULRICH'S UPDATE™

[Go](#) >

Ulrich's Update™ compiles data on new launches, title changes, title mergers, and cessations, on a monthly basis.

SERIALS RESOURCES

Strategic Services connects you with a range of alternative access and delivery systems, including A & I services, document delivery services, micropublishers, online & CD-ROM vendors, reprint services, and subscription agents.

Tap into an international network of online resources of practical interest to the serials community: serials interest groups, discussion groups & listservs, national libraries, library catalogues & catalogue tools, library associations, professional associations & societies, standards & standards organizations, reproduction rights organizations, circulation audit bureaus, and other reference sources.



00008791

MyHEAL-Link

E-mail: [input field]
Κωδικός: [input field] [Enter button]

ΕΓΓΡΑΦΗ ΝΕΟΥ ΜΕΛΟΥΣ - REGISTRATION

ΞΕΧΑΣΑ ΤΟΝ ΚΩΔΙΚΟ ΜΟΥ - FORGOT MY PASSWORD

Προσθήκη νέων τίτλων του DOAJ (Directory of Open Access Journals)

Σήμερα είναι διαθέσιμοι στους χρήστες του HEAL-Link 260 τίτλοι Open Access περιοδικών που διατίθενται από το DOAJ (Directory of Open Access Journals). Οι τίτλοι αυτοί έχουν ευρετηριαστεί και μπορούν να προσπελαστούν και από τη Θεματική Αναζήτηση και από τον Πραβητικό κατάλογο. Το Directory of Open Access Journals διαθέτει συνολικά πάνω από 1000 τίτλους επιστημονικών περιοδικών, το οποίο των οποίων θα είναι διαθέσιμο μέσω του HEAL-Link μόλις ολοκληρωθεί η απαραίτητη επεξεργασία τους.

2006-2004

Επιστροφή | Λίστα όλων των νέων



Search

• **Quick Search**

Search

• **Advanced Search**

Services

- **Alphabetic Index**
- **Subject Categories**
- **Bibliographic / Full Text Databases**
- **Electronic Books/Dictionary**
- **Publishers**

My HEAL-Link

E-mail:

Κωδικός:

Enter

- **New user**
- **Forgot password**
- **Usage guide**

Alphabetic Index

0-9 A B C D E F G H I J K L M N O P Q R S T U V W X Y Z

- **D** Wilson (2004 -)
- **D-Lib Magazine** DOAJ (Directory of Open Access Journals) (1995 -)
- **D-Lib Magazine** Wilson (2000 -)
- **DAC: Annual ACM IEEE Design Automation Conference** ACM (Association for Computing Machinery) (1964 -)
- **DARE: Designing Augmented Reality Environments** ACM (Association for Computing Machinery) (2000 only)
- **DARJ** DOAJ (Directory of Open Access Journals) (2002 -)
- **DATE: Design, Automation, and Test in Europe** ACM (Association for Computing Machinery) (1998 -)
- **Dados** DOAJ (Directory of Open Access Journals) (1996 -)
- **Dance Chronicle** Taylor & Francis (2001 -)
- **Danish Medical Bulletin** DOAJ (Directory of Open Access Journals) (2004 -)
- **Data & Knowledge Engineering** Elsevier (ScienceDirect) (1985 -)
- **Data Mining and Knowledge Discovery** SpringerLink (formerly Kluwer) (1997 -)
- **Data Processing (continued as Information and Software Technology)** Elsevier (ScienceDirect) (1981 - 1986)
- **Data Science Journal** DOAJ (Directory of Open Access Journals) (2002 -)



Web [Images](#) [video](#) [News](#) [Maps](#) [more »](#)

doaj

Search

[Advanced Search](#)
[Preferences](#)

Results 1 - 10 of about 4,210,000 for doaj. (0.11 seconds)

[Directory of open access journals](#)

Authorized, searchable links to free, full text, quality controlled scientific and scholarly journals.

[doaj.org/](#) - 8k - [Cached](#) - [Similar pages](#)

[New titles](#) - [www.doaj.org/new](#)

[Health Sciences](#) - [www.doaj.org/ljbs?cpid=20](#)

[Questions and Answers](#) - [www.doaj.org/articles/questions](#)

[Search articles](#) - [www.doaj.org/findarticles](#)

[More results from www.doaj.org »](#)

[Directory of open access journals](#)

Port DOAJ · For journal owners ... DOAJ - Directory of Open Access Journals, 2006, University Libraries, Head Office.

[doaj.org/findjournals](#) - 7k - [Cached](#) - [Similar pages](#)

[More results from www.doaj.org \]](#)

[PUB.US](#)

[scipub.us/c4p.php?j_id=ajid](#) - 1k - [Cached](#) - [Similar pages](#)

[J Home](#)

[Directory of Open Access Journals](#) · Google Scholar. ISSN: 1747-0862 Frequency: Quarterly Current Volume: 1 Current Issue: 2. Privacy | Disclaimer ...

[libpubmedia.co.uk/MedJ/MedJHome.htm](#) - 10k - [Cached](#) - [Similar pages](#)

[J | Science Buzz](#)

Currently 709 journals are searchable at the article level. As of today 118178 articles are indexed in the DOAJ service. ...

[doaj.org/buzz/buzz_tags/doaj](#) - 14k - [Cached](#) - [Similar pages](#)

[Libraries: DOAJ, the Directory of Open Access Journals ...](#)

This resource is a directory which provides free, full text, quality controlled scientific and scholarly journals. It aims to cover all subjects and ...

[asu.edu/lib/resources/db/doaj.htm](#) - 12k - [Cached](#) - [Similar pages](#)

Sponsored Links

[Publish Scholarly Journal](#)

We Promote Free and Open Access to Scholarly Knowledge!
[www.scholarlyexchange.org](#)



Web [Images](#) [Video](#) [News](#) [Maps](#) [more »](#)

directory of open access journals

Search

[Advanced Search](#)
[Preferences](#)

b

Results 1 - 10 of about 15,700,000 for [directory of open access journals](#). (0.14 seconds)

[Directory of open access journals](#)

Authorized, searchable links to free, full text, quality controlled scientific and scholarly journals.

[doaj.org/](#) - 8k - [Cached](#) - [Similar pages](#)

[New titles](#) - [www.doaj.org/new](#)

[Health Sciences](#) - [www.doaj.org/ljbs?cpid=20](#)

[Questions and Answers](#) - [www.doaj.org/articles/questions](#)

[Search articles](#) - [www.doaj.org/findarticles](#)

[More results from www.doaj.org »](#)

[Directory of open access journals](#)

[Journals](#) · [New titles](#) · [Find articles](#) · [Suggest a journal](#) · [About](#) · [FAQ](#) · [News](#) · [Contribution](#) · [Contact](#) · [Support DOAJ](#) · [For journal owners ...](#)

[doaj.org/findjournals](#) - 7k - [Cached](#) - [Similar pages](#)

[[More results from www.doaj.org](#)]

[Academic Leadership - The Online Journal](#)

The online **Journal** of Academic Leadership is aimed at all in the academy who care ... and encourage researchers to **open** a dialogue about these and similar questions. ...

[academicleadership.org/](#) - 28k - [Cached](#) - [Similar pages](#)

[Genders OnLine Journal - Presenting innovative theories in art ...](#)

A peer-reviewed academic **journal** publishing essays about gender and sexuality in relation to culture, political, artistic, and economic concerns.

[genders.org/](#) - 13k - [Cached](#) - [Similar pages](#)

[Professional Journal of the United States Air Force](#)

The Space Power **Journal**. "The professional flagship publication of the United States Air Force." Arabic Edition · [Chronicles Online Journal ...](#)

[airpower.maxwell.af.mil/airchronicles/apje.html](#) - 6k - [Cached](#) - [Similar pages](#)

[American Communication Journal](#)

The premier online scholarly refereed **journal** dedicated to the study of communication. Published by the American Communication Association.



So far ...

- Global visibility and dissemination of records
 - Integrated in OPAC's in many, many libraries
 - Several service providers are linking to DOAJ
 - Integrated in the services of aggregators (Serial Solutions, Ullrichs, Ebsco, OVID etc.)
 - And OpenURL-providers (Exlibris etc.)
- Frequently referred to as the most important listing



New functionality and developments in the pipeline!

- Service for authors: "where can I publish in OA and what are the conditions??"
- Integration of OA-articles from hybrid journals
- Working with journals to enable them in providing OAI-compliant article level metadata
- Secure long term funding:
 - Donations programme is launched



New service for authors

- **Where** can I publish in Open Access?
 - Gold (Open Access or Hybrid Journals)
 - Publication charges?
 - Green (Selfarchiving)
 - What (pre-/postprints)
 - Cost-Effectiveness
 - Price per article/citation etc.
 - Impact factor(?)
- **Advice** in Intellectual Property Rights Issues
- Integrated in Directory of Open Access Journals (DOAJ)

DOAJ

DIRECTORY OF OPEN ACCESS JOURNALS

[Find Journals](#)

[New titles](#)

[Search article](#)

[Suggest a journal](#)

[About](#)

[FAQ](#)

[News](#)

[Cooperation](#)

[Contact](#)

[Support DOAJ](#)

[For journal owners](#)

[For authors](#)

Welcome to the Directory of Open Access Journals. This service covers free, full text, quality controlled scientific and scholarly journals. We aim to cover all subjects and languages. There are now **2358** journals in the directory. Currently **683** journals are searchable at article level. As of today **107441** articles are included in the DOAJ service.

[Find journals](#)

[Browse by title](#)

[A](#) [B](#) [C](#) [D](#) [E](#) [F](#) [G](#) [H](#) [I](#) [J](#) [K](#) [L](#) [M](#) [N](#) [O](#) [P](#) [Q](#) [R](#) [S](#) [T](#) [U](#) [V](#) [W](#) [X](#) [Y](#) [Z](#)

[Browse by subject](#)

[Expand Subject Tree](#)

- [Agriculture and Food Sciences](#)
- [Arts and Architecture](#)
- [Biology and Life Sciences](#)
- [Business and Economics](#)
- [Chemistry](#)
- [Earth and Environmental Sciences](#)
- [Health Sciences](#)
- [History and Archaeology](#)
- [Languages and Literatures](#)
- [Law and Political Science](#)
- [Mathematics and Statistics](#)
- [Philosophy and Religion](#)
- [Physics and Astronomy](#)
- [Social Sciences](#)
- [Technology and Engineering](#)

DOAJ

DIRECTORY OF OPEN ACCESS & HYBRID JOURNALS

For authors



[Find Journals](#)

[New titles](#)

[Find articles](#)

[Suggest a journal](#)

[About](#)

[FAQ](#)

[News](#)

[Cooperation](#)

[Contact](#)

[Support DOAJ](#)

[For journal owners](#)

[For authors](#)

[Find journals](#)

[FAQ](#)

Welcome to the author service of DOAJ - The Directory of Open Access & Hybrid Journals. Here you can look up where to publish your research as **Open Access (OA)**.

[Find journals](#)

ALL Free to publish Author Pays to publish

[Browse by title](#)

[A](#) [B](#) [C](#) [D](#) [E](#) [F](#) [G](#) [H](#) [I](#) [J](#) [K](#) [L](#) [M](#) [N](#) [O](#) [P](#) [Q](#) [R](#) [S](#) [T](#) [U](#) [V](#) [W](#) [X](#) [Y](#) [Z](#)

[Browse by subject](#)

[Expand Subject Tree](#)

- [Agriculture and Food Sciences](#)
- [Arts and Architecture](#)
- [Biology and Life Sciences](#)
- [Business and Economics](#)
- [Chemistry](#)
- [Earth and Environmental Sciences](#)
- [General Works](#)
- [Health Sciences](#)
- [History and Archaeology](#)
- [Languages and Literatures](#)
- [Law and Political Science](#)
- [Mathematics and Statistics](#)
- [Philosophy and Religion](#)
- [Physics and Astronomy](#)
- [Science General](#)
- [Social Sciences](#)
- [Technology and Engineering](#)

[Find Journals](#)

[New titles](#)

[Search article](#)

[Suggest a journal](#)

[About](#)

[FAQ](#)

[News](#)

[Cooperation](#)

[Contact](#)

[Support DOAJ](#)

[For journal
owners](#)

[For authors](#)

[FAQ](#)

Browse by subject

[Expand Subject Tree](#)

[Subjects](#) ▶ [Biology and Life Sciences](#) ▶ [Life Sciences](#) ▶ [Biotechnology](#)

22 journals belonging to subject: **Biotechnology**

[AgBioforum](#) [Open Access](#)

ISSN: 1522936X

Subject: [Biotechnology](#)

Publisher: University of Missouri, Columbia, Agriculture & Engineering Department

Language: English

Keywords: agricultural economics, biotechnology, agriculture

Start Year: 1998

[American Journal of Biochemistry and Biotechnology](#) [Open Access](#)

ISSN: 15533468

Subject: [Biochemistry](#) --- [Biotechnology](#)

Publisher: Science Publications

Language: English

Keywords: life sciences, biochemistry, evolutionary biotechnology, structural biology, molecular biology, cellular biology, molecular medicine, cancer research, virology, immunology

Start Year: 2005

[Applied Biochemistry and Microbiology](#) [Hybrid journal](#)

ISSN: 00036838

Subject: [Microbiology](#) --- [Biology](#) --- [Biochemistry](#) --- [Biotechnology](#)

Publisher: Kluwer

[Find Journals](#)

[New titles](#)

[Find articles](#)

[Suggest a journal](#)

[About](#)

[FAQ](#)

[News](#)

[Cooperation](#)

[Contact](#)

[Support DOAJ](#)

[For journal
owners](#)

[For authors](#)

[Find journals](#)

[FAQ](#)

Authors FAQ

Publishing in Open Access scholarly journals: what are the options?

Q. What is an Open Access journal?

A. An OA-journal uses a funding model that does not charge subscription fees for access. The content is freely available to all.

Q. Why should I publish in an OA journal?

A. Making publications freely available electronically increases their use and the number of times they are cited. By making your publication freely available your impact will grow. See "The effect of open access and downloads ('hits') on citation impact: a bibliography of studies" for more information on this.
<http://opcit.eprints.org/oacitation-biblio.html>

Q. What about the quality of OA journals?

A. Scholarly OA journals use the same quality criteria as traditional subscription journals, i.e. external or internal peer-review.

Q. Where do I find OA journals?

A. In the [Directory of Open Access Journals](#). The Directory aims to be comprehensive and cover all open access scientific and scholarly journals that use a quality control system to guarantee the content. A journal is included in the DOAJ only if submitted papers are quality controlled through an editor, editorial board and/or a peer-review system.

Q. What is the author pays model?

A. The publishing cost is paid by the author- when his/her article is accepted by a journal. The article is free to all readers. The "author-pays" model has nothing to do with the fees charged by traditional subscription journals for colour prints and/or tables.

Q. What is a hybrid journal?

A. A journal based on traditional subscription revenues with the author pays model on

Publisher copyright policies & self-archiving

Statistics for the 169 publishers on this list

RoMEO colour	Archiving policy	Publishers	%
Green	can archive pre-print and post-print	76	45
Blue	can archive post-print (ie final draft post-refereeing)	42	25
Yellow	can archive pre-print (ie pre-refereeing)	15	9
White	archiving not formally supported	36	21

Summary: **79%** of publishers on this list formally **allow** some form of self-archiving.

Publisher copyright policies & self-archiving

Journal: **Reading and writing** (ISSN: 0922-4777)
 Publisher: **Springer Science + Business Media**

These summaries are for the publishers *default* policies and changes or exceptions can often be negotiated by authors.
Information is correct to the best of our knowledge but should not be relied upon for legal advice.

Publisher:	Springer Verlag (Germany)
Pre-print:	✓ author can archive pre-print (ie pre-refereeing)
Post-print:	✓ author can archive post-print (ie final draft post-refereeing)
Conditions:	<ul style="list-style-type: none"> • Author's own final version can be archived • On author's website or institutional repository • Published source must be acknowledged • Must link to publisher version • Set phrase to accompany link to published version • Articles in some journals can be made Open Access on payment of additional charge
Copyright:	view policy
RoMEO:	This is a RoMEO green publisher
Update:	suggest update for this record

Search again?

Search **Journal titles** **Publisher names**

for

find **contains** or **starts with** or **Exact** phrase only

RoMEO colour	Archiving policy
green	can archive pre-print and post-print
blue	can archive post-print (ie final draft post-refereeing)
yellow	can archive pre-print (ie pre-refereeing)
white	archiving not formally supported

[more on colours and restrictions](#)

Journal Cost-Effectiveness

Use this search engine to find internationally-published journals and rank them

Title:

Publisher:

ISSN:

Search

www.journalprices.com

Restrict your search to the following subject areas (unchecking all boxes searches all journals):

- Agriculture
- Biology
- Business
- Chemistry
- Computer Science
- Economics
- Education
- Engineering
- Geology
- History
- Humanities
- Law
- Mathematics
- Medicine
- Physics
- Psychology
- Social Science

Sort results by:

- Title
- Publisher
- ISSN
- Year First Published
- Price Per Article
- Price Per Citation
- Composite Price Index
- Relative Cost Index

Order results:

- Ascending
- Descending

Limit to:

- Good value
- Medium value
- Bad value

Format results as tab-delimited text for saving or copying to Excel. Do not paste directly into wordpad or excel. Copying and then pasting into notepad, saving

Annual Review of Psychology

Publ: ANNUAL REVIEWS

Profit Status: non-profit

Price per article: 7.16

Price per citation: 0.51

IF 12,8

Psychological Bulletin

Publ: AM PSYCHOL ASS

Profit Status: non-profit

Price per article: 11.92

Price per citation: 0.78

IF 7,7

Cognitive Psychology

Publ: Elsevier

Profit Status: profit

Price per article: 35.10

Price per citation: 4.32

IF 3,98

Personnel Review

Publ: EMERALD

Profit Status: profit

Price per article: 360.09

Price per citation: 744.52

0

[Find journals](#)
[New titles](#)
[Search articles](#)
[Suggest a journal](#)

[About](#)
[Questions & answers](#)
[News](#)
[Cooperation](#)
[Contact](#)
[Support DOAJ](#)
[OpenDOAR](#)

For journal owners

Cooperation



LUND
UNIVERSITY



[OSI](#)

AXIELL



[SPARC](#)



[BIBSAM](#)



[SPARC Europe](#)

We would like to thank all who send us journal suggestions we appreciate the contribution to make DOAJ as complete and updated as possible.

We look forward to further collaboration with other libraries, organisations and people who wants to contribute to the further work in making open access journals more visible.

DOAJ - Directory of Open Access Journals, 2006, [Lund University Libraries](#), Head Office

No funding from Jan 2007 –
we need your support!!



Part II

Integration of Open Access content in our library services



Promoting Open Access content in our library services

- Now that we have convinced so many researchers to publish in Open Access
- &
- Now that many (not for profit) publishers are considering Open Access publishing

Then

- We have to do whatever we can to expose the Open Access content to the eyes of our users!!

How do we do that??



OA-content from subject or institutional repositories

- Examples:
 - OAIster –
<http://oaister.umdl.umich.edu/o/oaister/>
 - BASE – Bielefeld Academic Search Engine -
<http://www.base-search.net/>
 - SHERPA Search -
<http://www.sherpa.ac.uk/repositories/sherpasearch.html>



OA-content from OA-journals

- **Subscription agents:**
 - Some subscription agents like Swets, Ebsco etc. offer inclusion of Open Access Journals in their services
 - If not – ask for it!!
- **ERM-providers:**
 - Electronic Resource Management providers should as well offer inclusion of Open Access Journals in their services
 - If not – ask for it!!
- **OpenURL-providers**
 - OpenURL-providers (like Exlibris, Endeavour, Innovative Interfaces etc) offer inclusion of Open Access journals in their knowledge bases
 - If not – ask for it!!
- **Library Consortia & Cooperatives:**
 - Library Consortia & Cooperatives could share the work and facilitate inclusion of Open Access journal records in their OPACs and other services.



Going one step further

- It is good that Open Access Journals are visible on title level in A-Z title lists, in the OPAC etc., but...
- What we really would like to see is that OA-content from OA-journals and from OA-repositories is exposed to our users **completely integrated** with the content from commercial and not-for-profit toll access publishers.
- This is what we try to accomplish in Lund!



Adressing the problems

- The problems:
 - Numerous databases and journal providers
 - numerous interfaces
 - Several thousand e-journals difficult to find
 - Portals provided by subscription agents and journals publishers are **not invented primarily to accomodate end user needs** but more to generate their business.



Finding information

- **Library branding is very important**
 - users often believe that full-text e-journals are free on the Internet!
 - "If it is not on the web, it does not exist"
- We want to brand our services and promote **Open Access resources**

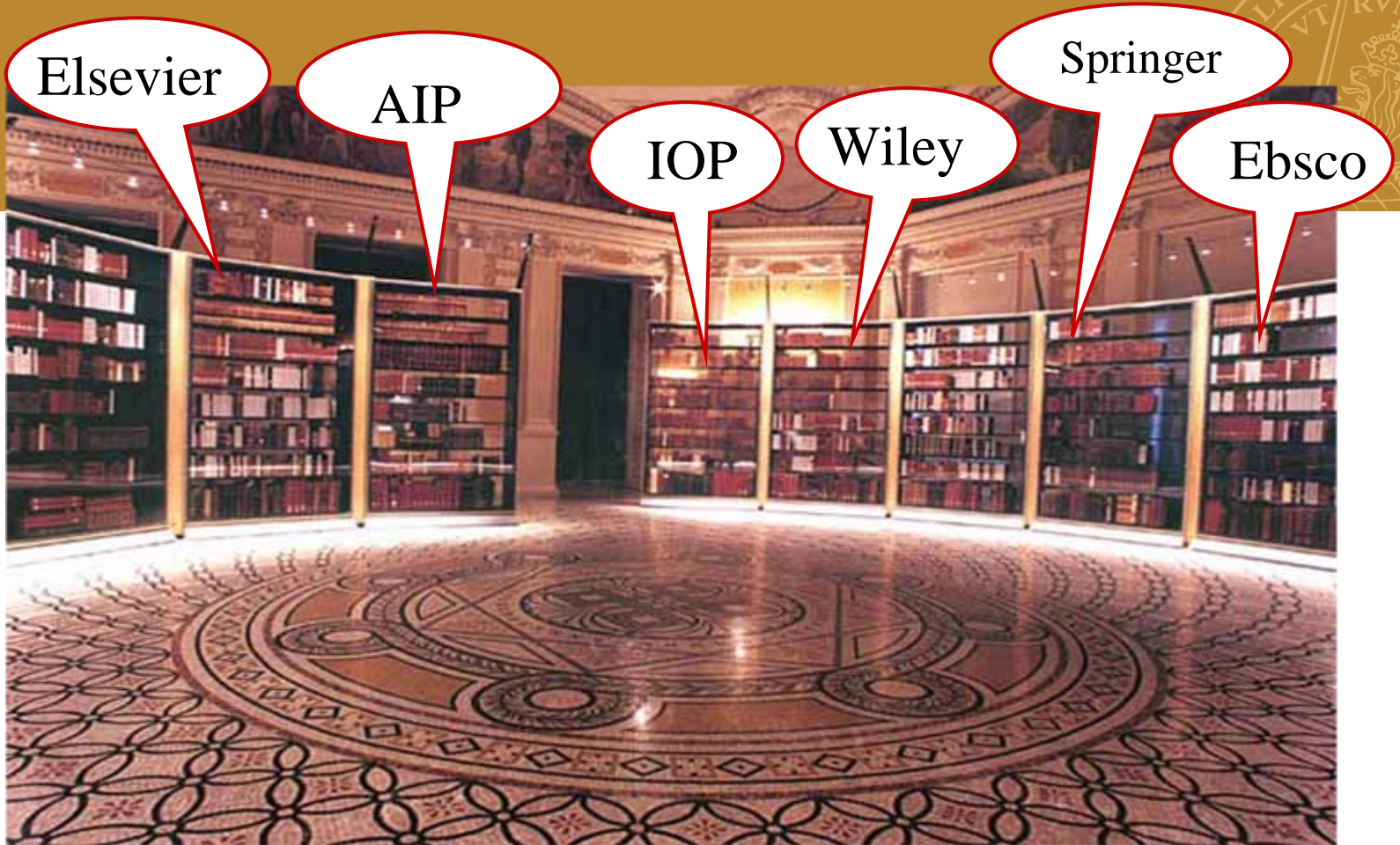

Publisher trap?



Additives for Polymers

Copyright © 2006 Elsevier Ltd. All rights reserved.

 Shortcut URL to this page: <http://www.sciencedirect.com/science/journal/03063747>

 Alert me about new Journal Issues

 Add to Favorites

Apply

[Sample Issue Online](#) | [About this Journal](#) | [Submit your Article](#)
 = subscribed = free
 = non-subscribed

Volume 2006 (2006)

- [Volume 2006, Issue 7](#)
pp. 2-12 (July 2006)
- [Volume 2006, Issue 5, Page 2-12](#) (May 2006)
- [Volume 2006, Issue 3](#)
pp. 2-12 (March 2006)
- [Volume 2006, Issue 2](#)
pp. 2-12 (February 2006)
- [Volume 2006, Issue 1](#)
pp. 2-12 (January 2006)
- [Volume 2005 \(2005\)](#)
- [Volume 2004 \(2004\)](#)
- [Volume 2003 \(2003\)](#)
- [Volume 2002 \(2001 - 2002\)](#)
- [Volume 2001 \(2001\)](#)
- [Volume 2000 \(2000\)](#)
- [Volume 1999 \(1999\)](#)
- [Volume 1998 \(1998\)](#)
- [Volume 1997 \(1997\)](#)
- [Volume 1996 \(1996\)](#)
- [Volume 1995 \(1995\)](#)
- [Volume 1994 \(1994\)](#)
- [Volume 1993 \(1993\)](#)
- [Volume 1992 \(1992\)](#)
- [Volume 1991 \(1991\)](#)
- [Volume 1990 \(1990\)](#)
- [Volume 19 \(1989\)](#)
- [Volume 18 \(1988\)](#)

Volume 2006, Issue 7, Pages 2-12 (July 2006)

Previous vol/iss No next vol/iss

Article List Full Abstracts

Add to my Quick Links

 Selected articles E-mail articles Export citations

articles 1 - 18

1. **Croda develops release agent for polystyrene** • NEWS
Page 2
[SummaryPlus](#) | [Full Text + Links](#) | [PDF \(29 K\)](#)
2. **DuPont P&IP launches new high-performance modifiers** • NEWS
Pages 2-3
[SummaryPlus](#) | [Full Text + Links](#) | [PDF \(34 K\)](#)
3. **Ampacet introduces new photoluminescent masterbatches, expands colour capacity** • NEWS
Page 3
[SummaryPlus](#) | [Full Text + Links](#) | [PDF \(29 K\)](#)
4. **Milliken Chemical unveils nucleator for PE blown films** • NEWS
Page 4
[SummaryPlus](#) | [Full Text + Links](#) | [PDF \(29 K\)](#)
5. **PolyOne reveals new products for wire and cable** • NEWS
Pages 4-5
[SummaryPlus](#) | [Full Text + Links](#) | [PDF \(34 K\)](#)
6. **BASF, Engelhard reach agreement on acquisition** • NEWS
Page 5
[SummaryPlus](#) | [Full Text + Links](#) | [PDF \(29 K\)](#)
7. **Emerald Performance Materials formed from sold Lubrizol businesses** • NEWS
Pages 5-6
[SummaryPlus](#) | [Full Text + Links](#) | [PDF \(39 K\)](#)
8. **Dyneon expands polymer additives lab capabilities in India, China** • NEWS
Page 6



- Athena Academic Point
- Recognized as:**
- Lund University Libraries (004-41-587)
- 1018 BIBSAM SWED (166-07-318)
- 1238 BIBSAM LNCS Sweden (109-11-626)
- 1292 BIBSAM LABO Sweden (928-54-680)
- 1301 BIBSAM Brill (888-51-274)
- BIBSAM - OJA (753-22-534)

Welcome!

To use the personalized features of this site, please [log in](#) or [register](#).

If you have forgotten your username or password, we can help.

- My SpringerLink**
- Marked Items
- Alerts
- Order History
- Saved Items**
- All
- Favorites



Journal

Acta Mathematica Sinica

Publisher Springer Berlin / Heidelberg

ISSN 1439-8516 (Print) 1439-7617 (Online)

Online Date Friday, April 05, 2002

Subject Mathematics and Statistics and Chinese Library of Science

- Add to marked items**
- Add to saved items
 - Register for TOC Alerting
 - Recommend this journal
 - Editorial Board
 - About This Journal
 - Manuscript Submission

Editorial View Expanded List View Condensed List View

11 Volumes First | **Current-17** | 16-13 | 12-9 | 8-5 | Next

Access to all content Access to some content Access to no content

<input checked="" type="checkbox"/>	Volume 22	
<input checked="" type="checkbox"/>	Number 5 / September, 2006	1283-1602
<input checked="" type="checkbox"/>	Number 4 / July, 2006	963-1282
<input checked="" type="checkbox"/>	Number 3 / May, 2006	641-962
<input checked="" type="checkbox"/>	Number 2 / April, 2006	319-640
<input checked="" type="checkbox"/>	Number 1 / January, 2006	1-318
<input checked="" type="checkbox"/>	Volume 21	
<input checked="" type="checkbox"/>	Number 6 / December, 2005	1249-1544
<input checked="" type="checkbox"/>	Number 5 / October, 2005	961-1248
<input checked="" type="checkbox"/>	Number 4 / August, 2005	673-960
<input checked="" type="checkbox"/>	Number 3 / June, 2005	449-672
<input checked="" type="checkbox"/>	Number 2 / April, 2005	225-448
<input checked="" type="checkbox"/>	Number 1 / February, 2005	1-224
<input checked="" type="checkbox"/>	Volume 20	
<input checked="" type="checkbox"/>	Number 6 / November, 2004	961-1152
<input checked="" type="checkbox"/>	Number 5 / September, 2004	769-960
<input checked="" type="checkbox"/>	Number 4 / July, 2004	577-768

Find more options

...

- Within this journal
- Within all content

Starts With

a b c d e f g h i j k l m n o
p q r s t u v w x y z space
more

Content Status

OnlineFirst™ (93)
Published (879)

Online Date

In the last six months (124)
In the last year (417)

Author

- Chong Li (6)
- Gang Tian (4)
- Shan Zhen Lu (4)
- Li Xin Zhang (3)
- Fang Li (3)
- Song Li (3)
- Peter Šemrl (2)
- Hitoshi Tanaka (2)
- Shu Wang (2)
- Hua Chen (2)

Article Category



Advances in Polymer Technology

See Also:

[Advances in Polymer Technology 1981 - 1995](#)
 [What is RSS?](#)

Copyright © 2006 Wiley Periodicals, Inc., A Wiley Company

-  [Get Sample Copy](#)
-  [Save Title to My Profile](#)
-  [Recommend to Your Librarian](#)
-  [Set E-Mail Alert](#)

 e-mail  print

[Journal Home](#) | [Issues](#)
[Product Information](#) | [Editorial Board](#) | [For Authors](#) | [Subscribe](#) | [Advertise](#) | [Contact](#)

CURRENT ISSUE

Volume 25, Issue 2 (Summer 2006)

Articles in the Current Issue:

Features

Mixing immiscible blends in an intermeshing counter-rotating twin screw extruder (p 81-89)

Ramesh Potturi, David Todd, Costas Gogos

Published Online: 8 Jun 2006

DOI: 10.1002/adv.20065

[Abstract](#) | [References](#) | Full Text: [PDF](#) (Size: 655K)

 [Save Article](#)
An analysis of the effect of elongational viscosity on the flow in a spiral-mandrel die (p 90-97)

Y. Sun, M. Gupta

Published Online: 8 Jun 2006

DOI: 10.1002/adv.20061

[Abstract](#) | [References](#) | Full Text: [PDF](#) (Size: 571K)

 [Save Article](#)
Factors affecting the formation of fingering in water-assisted injection-molded thermoplastics (p 98-108)

Shih-Jung Liu, Shih-Po Lin

Published Online: 8 Jun 2006

DOI: 10.1002/adv.20062

[Abstract](#) | [References](#) | Full Text: [PDF](#) (Size: 317K)

 [Save Article](#)
Radiation curing of diacrylate glycerolate of bisphenol-A in the presence of an organically modified montmorillonite for the production of flame-resistant polymer-clay composites (p 109-120)

Giuseppe Spadaro, Clelia Dispenza, Sabina Alessi, Giuseppina Tartaglione, Giovanni Camino

Published Online: 8 Jun 2006

DOI: 10.1002/adv.20063

[Abstract](#) | [References](#) | Full Text: [PDF](#) (Size: 494K)

 [Save Article](#)
Processing of PEMFC membranes by extrusion: Part 1. Sulfonated polysulfone in acid form (p 121-126)
[< Previous Issue](#) | [Next Issue >](#)
SEARCH All Content

 Publication Titles

[Advanced Search](#)
[CrossRef / Google Search](#)
[Acronym Finder](#)

SEARCH IN THIS TITLE

Advances in Polymer Technology

 All Fields

SEARCH BY CITATION

Vol: Issue: Page:

PROVIDED BY

 Lund University Libraries

SPECIAL FEATURES

- [Other Resources](#)

ARTICLE REPRINTS



Need an article reprint?

Paper or electronic reprints are available for all articles published on Wiley InterScience. Inquiries can be submitted online.

[Find out more about reprints](#)

Our answer to the demand for integration of OA-content in modern library services



**ELIN@ - an interface to
hybrid library resources
developed by a library for
libraries**



Organising end user access

- **The goals:**
 - Integration of all services
 - Development of personalized services
 - Branding of library services
- **Principles:**
 - Single sign on – automatic authentication – one login/password to all resources
 - Remote access

Basic Search

[Simple Search](#) [Basic Search](#) [Advanced Search](#)

Search for:

oai-pmh

in: All Fields AND

Search for:

in: All Fields Publication year: All years From: 2005 To: 2006 Only documents available in full text[ELIN content providers](#)

Search result

Query: (all:oai-pmh) AND year:[2005 TO 2006]

Found: 26 matches

presenting page 1 / 2

[Next 6 records >](#)[Add search query to collection](#)

Refine your search:

AND

in:

All Fields

▼

Search

1 . [An Architecture for the Aggregation and Analysis of Scholarly Usage Data](#)**Authors:** Bollen Johan; VandeSompel Herbert**Year:** 2006 **Provider:** arXiv[Fulltext](#) | [Add to collection](#)2 . [Search Engine Coverage of the OAI-PMH Corpus](#)**Authors:** McCown, F.; Liu, X.; Nelson, M.L.; Zubair, M.; Liu, X.**Journal:** IEEE Internet Computing **Year:** 2006 **Volume:** 10 **Issue:** 2 **Pages:** 66-73 **Provider:** IEEE[Fulltext](#) | [Add to collection](#)3 . [Representing digital assets using MPEG-21 Digital Item Declaration](#)**Authors:** Bekaert, Jeroen; Kooning, Emiel De; Sompel, Herbert van de**Journal:** International Journal on Digital Libraries **Year:** 2006 **Volume:** 6 **Issue:** 2 **Pages:** 159-173 **Provider:** Springer[Fulltext](#) | [Add to collection](#)4 . [Metadata harvesting in regional digital libraries in the PIONIER network](#)**Authors:** Mazurek, Cezary; Stroinski, Maciej; Werla, Marcin; Weglarz, Jan**Journal:** Campus-Wide Information Systems **Year:** 2006 **Volume:** 23 **Issue:** 4 **Pages:** 241-253 **Provider:** Catchword[Fulltext](#) | [Add to collection](#)

7 . [Japanese Virtual Observatory \(JVO\) as an advanced astronomical research environment](#)

Authors: Shirasaki Y.; Tanaka M.; Kawanomoto S.; Honda S.; Ohishi M.; Mizumoto Y.; Yasuda N.; Masunaga Y.; Ishihara Y.; Tsutsumi J.; Nakamoto H.; Kobayashi Y.; Sakamoto M.

Year: 2006 **Pages:** 13 **Provider:** arXiv

[Fulltext](#) | [Add to collection](#)

8 . [Metadata aggregation and 'automated digital libraries': A retrospective on the NSDL experience](#)

Authors: Lagoze Carl; Krafft Dean; Cornwell Tim; Dushay Naomi; Eckstrom Dean; Saylor John

Year: 2006 **Provider:** arXiv

[Fulltext](#) | [Add to collection](#)

9 . [CDSware \(CERN Document Server Software\)](#)

Authors: Sitas, Anestis

Journal: Library Hi Tech **Year:** 2006 **Volume:** 24 **Issue:** 3 **Pages:** 420-429 **Provider:** Catchword

[Fulltext](#) | [Add to collection](#)

10 . [The convergence of digital libraries and the peer-review process](#)

Authors: Rodriguez Marko A.; Bollen Johan; Van de Sompel Herbert

Journal: Journal of Information Science **Year:** 2006 **Volume:** 32 **Issue:** 2 **Pages:** 149-159 **Provider:** HighWire

[Fulltext](#) | [Add to collection](#)

11 . [Using OAI-PMH and METS for exporting metadata and digital objects between repositories](#)

Authors: Bell, Jonathan; Lewis, Stuart

Journal: Program (London, 1966) **Year:** 2006 **Volume:** 40 **Issue:** 3 **Pages:** 268-276 **Provider:** Catchword

[Fulltext](#) | [Add to collection](#)

12 . [From education to e-learning: a union catalog service of learning resources](#)

Authors: Pei-Xian Kuo; Jyun-Jie Yan; Jan-Ming Ho

Journal: e-Technology, e-Commerce and e-Service, 2005. EEE '05. Proceedings. The 2005 IEEE International Conference on **Year:** 2005 **Pages:** 582-587 **Provider:** IEEE

[Fulltext](#) | [Add to collection](#)

13 . [Integrated Application of Metadata and OAI-PMH to Digital News Archive](#)

Authors: Sinn-Cheng Lin; Pei-Shiun Kang

Journal: Journal of Educational Media & Library Sciences **Year:** 2005 **Volume:** 43 **Issue:** 1 **Pages:** 49-68 **Provider:** Tamkang University Press-- DOAJ

[Fulltext](#) | [Add to collection](#)

- Home
- By subject
- Articles
- Journals
- Ebooks
- Databases & links
- Suggest a resource
- My collection
- ars Bjørnshauge
- Logout
- My articles
- My Searches
- My journals
- My ebooks
- My databases & links
- My personal links

<< [Previous record](#)

[Next record](#)

[Fulltext](#)

[Add to collection](#)

[Table of content](#)

[Export](#)

[Return to search result page 1](#)

Title

Integrated Application of Metadata and OAI-PMH to Digital News Archive

Authors

[Sinn-Cheng Lin](#); [Pei-Shiun Kang](#)

Abstract

This paper studies the metadata integration problem between the Taiwan Baseball News Database and the Union Catalog of National Digital Archives Program. First, we design a metadata transformation system which can transform the news articles to four popular metadata formats: DC, NITF, RSS and DAC. The system not only supports metadata transformation but also RSS subscription and batch exportation for Union Catalog. Secondly, based on the OAI-PMH architecture, the digital news archives plays a role as Repository, and then we extend the system to be a Data Provider. It can be queried by any Service Provider, parse the Verbs, and then respond the Record Sets to the Service Provider in certain metadata format. As a result, the digital news can be delivered more efficient.

Key words

[Digital archive](#); [Metadata](#); [Makeup language](#); [Union catalog](#); [OAI-PMH](#)

Journal

[Journal of Educational Media & Library Sciences](#)

Publisher

Tamkang University Press

Issn

1013090X

Year

2005

Volume

43

Issue

1

Pages

49-68

Provider

Tamkang University Press-- DOAJ

Link to this page:

<http://www.lub.lu.se/cgi-bin/ipchk/http://elin.lub.lu.se/link2elin?genre=article&issn=1013090X&year=2005&volume=43&issue=1&collection>

Journal of Educational Media & Library Sciences

ne

subject

cles

ournals

oks

atabases & links

uggest a resource

collection

Bjørnshauge

out

articles

Searches

journals

ebooks

atabases & links

personal links

University Libraries

Publisher: Tamkang University Press**Fulltext:** Yes[Journal homepage at remote site\(2003-\) -- Free open access](#)[Add to collection](#)

Search this journal:

in:

All Fields



Search

TOC provided by **Publisher**

Year	Volume-Issue	Pages	Fulltext
2006	Volume: 43 Issue:3	pages (267-374)	Yes
2005	Volume: 43 Issue:2	pages (129-266)	Yes
2005	Volume: 43 Issue:1	pages (1-127)	Yes
2005	Volume: 42 Issue:4	pages (455-576)	Yes
2005	Volume: 42 Issue:3	pages (313-449)	Yes
2004	Volume: 42 Issue:2	pages (157-312)	Yes
2004	Volume: 42 Issue:1	pages (1-155)	Yes
2004	Volume: 41 Issue:4	pages (431-581)	Yes
2004	Volume: 41 Issue:3	pages (283-429)	Yes
2003	Volume: 41 Issue:2	pages (139-281)	Yes
2003	Volume: 41 Issue:1	pages (1-138)	Yes
2003	Volume: 40 Issue:4	pages (409-566)	Yes
2003	Volume: 40 Issue:3	pages (271-406)	Yes

My collection

Account Info

My articles

[Computers in Libraries Conference, Washington, DC](#)[Delete from collection](#)[Add/Edit a note](#)[Content in institutional repositories: a collection management issue](#)[Delete from collection](#)[Add/Edit a note](#)[Institutional Repositories: Essential Infrastructure For Scholarship In The Digital Age](#)[Delete from collection](#)[Add/Edit a note](#)[Institutional repositories: the library's new role](#)[Delete from collection](#)[Add/Edit a note](#)[Integrated Application of Metadata and OAI-PMH to Digital News Archive](#)[Delete from collection](#)[Add/Edit a note](#)[OAI compliant institutional repositories and the role of library staff](#)[Delete from collection](#)[Add/Edit a note](#)[Open access to scientific publications - an analysis of the barriers to change](#)[Delete from collection](#)[Add/Edit a note](#)[Performance, Processes and Costs: Managing Service Quality with the Balanced Scorecard.](#)[Delete from collection](#)[Add/Edit a note](#)[The DAEDALUS project, developing institutional repositories at Glasgow University: the story so far](#)[Delete from collection](#)[Add/Edit a note](#)[The early molecular response to imatinib predicts cytogenetic and clinical outcome in chronic myeloid leukaemia](#)[Delete from collection](#)[Add/Edit a note](#)

My search queries and ELIN article alert

[ti:"electronic publishing" OR kw:"electronic publishing" OR abs:"electronic publishing"](#)[Delete from collection](#)

[publishing"](#)

[all:"virtual universities"](#)

[Delete from collection](#)

[kw:"Myers-Briggs Type Indicator"](#)

[Delete from collection](#)

My journals and table of content alert

[Dados - Revista de Ciências Sociais](#)

[Delete from Collection](#)

[Delete from TOC alert](#)

[Add/Edit a note](#)

[Library and Information Science Research](#)

[Delete from Collection](#)

[Delete from TOC alert](#)

[Add/Edit a note](#)

[Library Consortium Management: An International Journal](#)

[Delete from Collection](#)

[Delete from TOC alert](#)

[Add/Edit a note](#)

[Library Hi Tech](#)

[Delete from Collection](#)

[Delete from TOC alert](#)

[Add/Edit a note](#)

[Library Management](#)

[Delete from Collection](#)

[Delete from TOC alert](#)

[Add/Edit a note](#)

[portal: Libraries and the Academy](#)

[Delete from Collection](#)

[Delete from TOC alert](#)

[Add/Edit a note](#)

[The Bottom Line: Managing Library Finances](#)

[Delete from Collection](#)

[Delete from TOC alert](#)

[Add/Edit a note](#)

[The Electronic Library](#)

[Delete from Collection](#)

[Delete from TOC alert](#)

[Add/Edit a note](#)

[The International Information & Library Review](#)

[Delete from Collection](#)

[Delete from TOC alert](#)

[Add/Edit a note](#)

My ebooks

My databases & links

[LISA: Library & Information Science Abstracts \(CSA\)](#)

[Info](#)

[Delete from collection](#)

[Add/Edit a note](#)

My personal links

[Add link](#)



ELIN@ - systems architecture

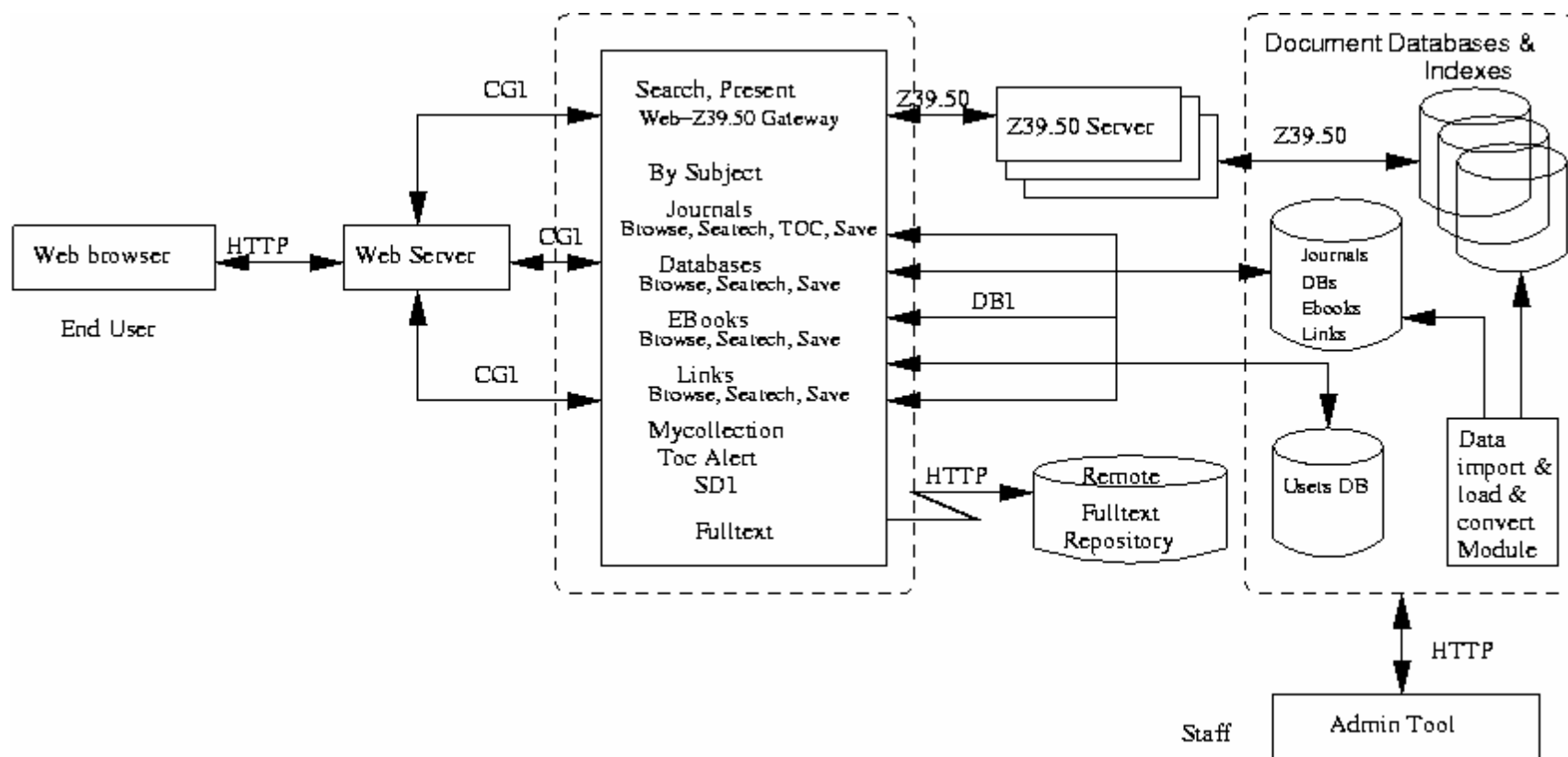



Integration of Library Services – Towards the one stop shop

- OPAC –printed collections
- Databases, encyclopedias, reference works etc.
- Electronic journals
- **Open access resources**
 - **Open Access Journals**
 - **E- & preprint archives, institutional repositories**
 - **Subject gateways**



Personalization

- "My Library"
 - Recommended resources – selected by subject librarians
 - Add your personal favourites
- SDI-alerts from databases, journals etc.
- TOC-alerts
- Users register at one site for all alerts

ELIN@ - Electronic Library Information Navigator



- Advantages for end users:
 - One interface for all content
 - Cross search documents from multiple sources – open access or licensed
 - Document delivery services for documents not available in Full Text
 - ToC alerts and SDI's
 - Integration with reference management tools

ELIN@ - Electronic Library Information Navigator



- Advantages for librarians:
 - Enhancing availability and visibility of scientific literature
 - Increasing e-journal cost efficiency – Usage is boosting
 - Administrative functions/Management tools:
 - Customization, Statistics, Collection Management, Budgeting, Marketing
 - Subscription administration functionalities



ELIN@ - Electronic Library Information Navigator

- **Contents (Oct 2006)**
 - +15.600 journals, whereof
 - +14.400 journals with metadata (cross searchable on article level)
 - +34,000,000 article level records
 - Databases
 - E-print archives



ELIN@ -partners

- 9 universities & university colleges in Sweden
- Nordic Asian Institutes
- Aarhus Business School, Denmark
- University of Gent, Belgium
- Makerere University, Uganda
- National University of Rwanda
- Vietnam: Legal departments
- 10 universities in Pakistan – 90 more in the pipeline
- In the pipeline:
 - African Virtual University
 - Cuba
 - Ghana

Search
P go

Component 4



- [Introduction](#)
- [Delivers information](#)
- [Disseminates national and regional research](#)
- [Enhances ICT skills](#)
- [Strengthens local publishing](#)
- [Supports country collaboration and working](#)
- [Research and development](#)
- [Enable countries](#)

Electronic Library Information Navigator (ELIN@)

The development of the ELIN@PERI application and pilot implementation is being undertaken during 2004-2006. Initially the project will involve software development and modification by Lund University Library, then training and pilot implementation in a small number of selected PERI partners, followed by a review and evaluation period. Once these three stages have been completed, a decision will be made on extending the project and releasing the application under an open source license.

- ◆ **[News and latest developments](#)**

- ◆ [ELIN@ pilot review](#)
- ◆ [Background to the development of ELIN@](#)
- ◆ [Benefits of ELIN@](#)
- ◆ [ELIN@PERI developments](#)
- ◆ [What ELIN@ means for the end user and their institution](#)
- ◆ [Pilot system objectives](#)
- ◆ [Technical overview](#)
- ◆ [What an ELIN@PERI screen might look like](#)
- ◆ [Virtual tour of ELIN@Lund](#) [This is included as an MS Word document that is 988Kb in size (compressed using [WinZip](#)) may take some time to download over a slow connection.]

For more information contact Martin Belcher at INASP (m.belcher@inasp.info). Section last updated: **11 October 2006**



Thank you for your attention!



Links

- DOAJ – www.doaj.org
- Donations to DOAJ – www.doaj.org/articles/donation
- Information on the ELIN@ system
<http://www.lub.lu.se/headoffice/elininfo.shtml>
- Electronic Library Information Navigator (ELIN@)
<http://www.inasp.info/peri/elin/>

Lars Björnshauge – lars.bjornshauge@lub.lu.se